

Version 4.0 Year 2026

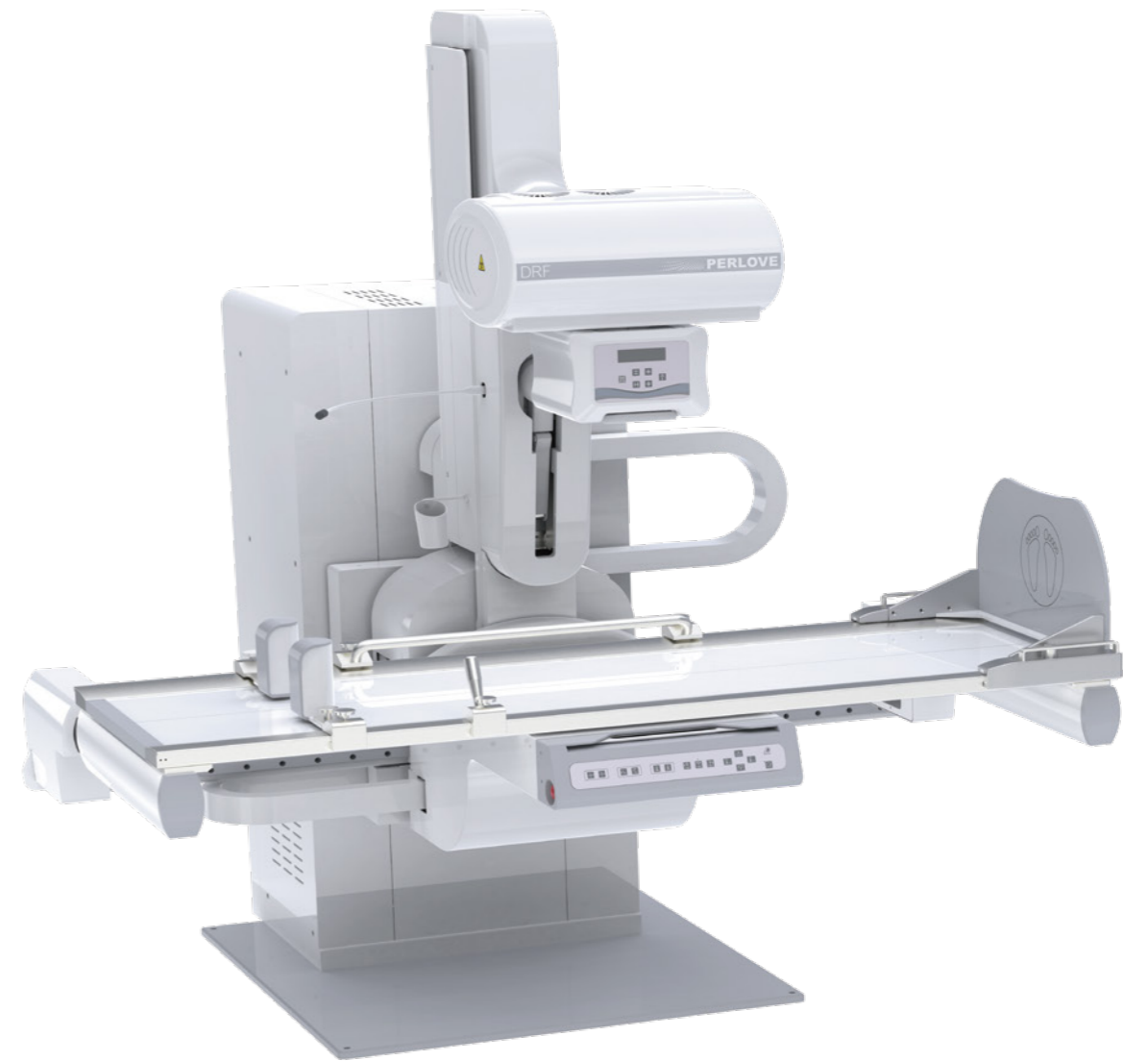



Industry Leader, Trusted by Customers



Work hard for
more than 20 years



General radiology equipment
one-stop supplier



Mobile products have led the
domestic market share for more
than 10 consecutive years



Nearly 40,000 square
meters of production
and office area



Medical X-ray national
standard-setting unit



Sold to more than 100
countries and regions
around the world

High performance and intelligent



Digital radiography

Meet the needs all parts of the human body, including special positioning radiography.



Digital fluoroscopy

It is suitable for fluoroscopy of various parts of the body (such as chest, abdominal, etc.)



Digital angiography

Partial angiography, such as esophagography, pyelography, salpingography.



Precise digital spot imaging

Obtain high-definition images and accurately capture lesions during fluoroscopy, avoiding missed diagnoses and misdiagnosis caused by blind shots.

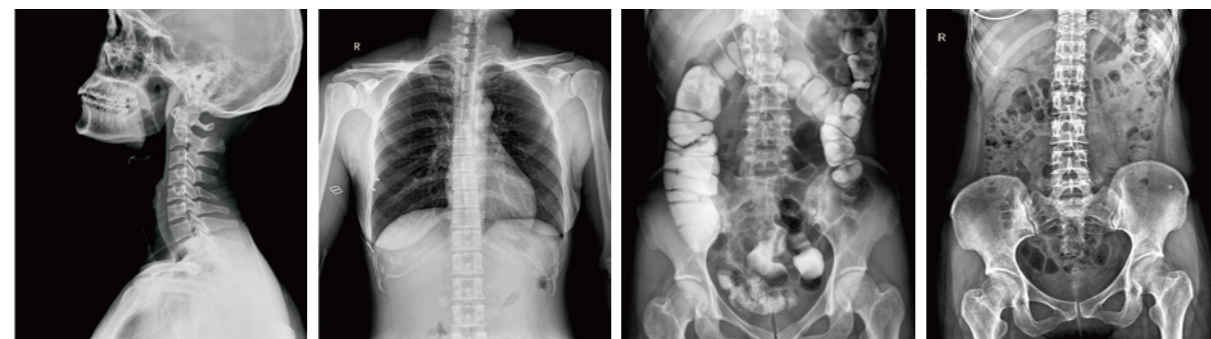

Domestic first push bed lift function
High-end and practical
(Optional)



The large-angle swinging
can meet the radiography
needs of all parts
(Optional)



Dynamic acquisition at 30 fps
Clearer and smoother images



Self-developed high frequency
high voltage generator



Imported large heat capacity tube
Good heat dissipation, long service life



Imported flat panel detector
(Optional)

Clinical applications



Orthopaedics



Respiratory Unit



Gastroenterology



Gynecology



Emergency Department



Medical Examination



Fever Clinic



Traumatology



Urology

High quality digital image chain

High frame rate dynamic flat panel detector



(Imported flat panel detector is Optional)

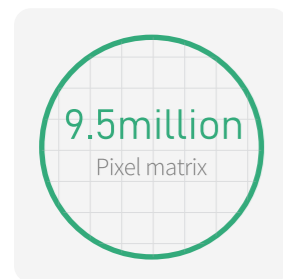

Self-developed high power and high frequency generator

- 500kHz ultra-high inverter frequency, maximum tube current 1000mA, stable radiation output, excellent radiation quality, good imaging effect.
- High-power high voltage generator to ensure high quality and stable radiation output.
- Self-developed, worry-free after-sales service, low maintenance costs.



Original imported high-speed tube with large heat capacity

- Imported high speed tube.
- Suitable for long time high intensity exposure work.
- High rotating speed, fast heat dissipation and long service life.



Double high density grids

- Two high-density grids as standard, dedicated to the distance.
- The grid can be removed for low-dose examinations.



One push button on/off switch

- One button push to turn on/off the machine, which simplifies overall workflow, saving preparation time.



Automatic electric beam limiter

- Quickly select and preset the desired field of view, saving time in positioning.
- One key switching of the beam range, efficient and convenient.



LCD touch screen workstation(Optional)

- Intelligent remote sensing, making physician examinations easy and convenient.
- All the operating buttons are accompanied by text and icons, making it easy and convenient.



Multi-dimensional movement

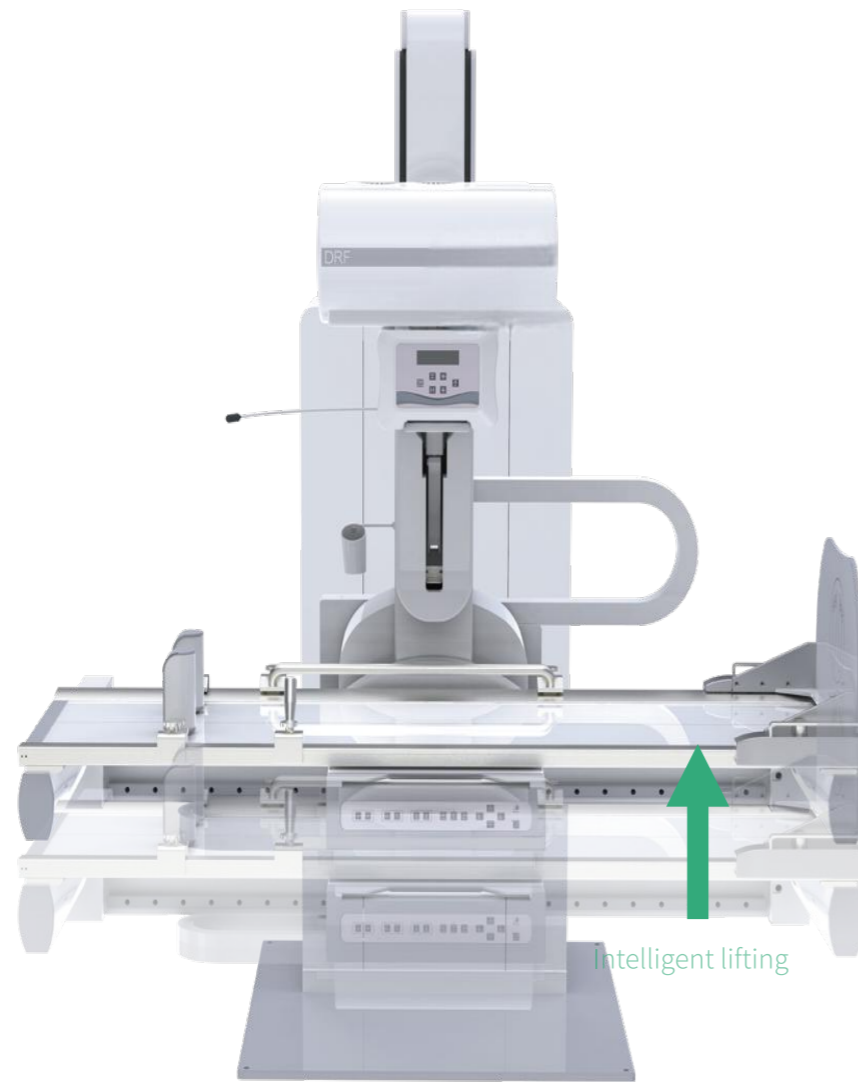

Intelligent bed lifting (Optional)

Exclusive table lifting/descending function not only supply convenience for patients with poor mobility but also can avoid secondary injuries in the case of acute and severe patient transfer. Meanwhile, doctors can be benefited from regulating the distance during near-table operation as well.

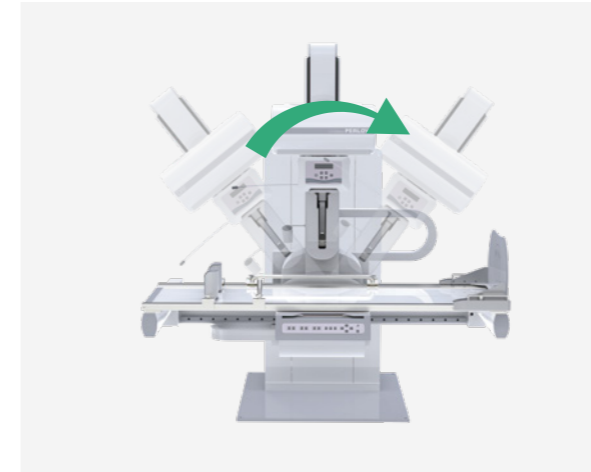

Tube column swing (Optional) ±90° Freely rotation design (Optional)

The large angle of the Tube can be tilted from -45° to 45° , meet clinical radiography needs of special parts. Such as, axial root bone, axial patella, cervical spine, sinus Varicoceles, Meyers, etc.

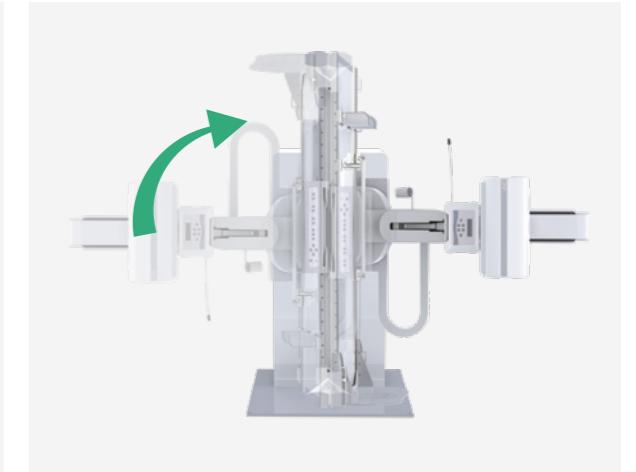

The table can be rotated 90 degrees vertically which greatly extends the clinical application. Meanwhile it moves steady and quietly, which can make the life longer.

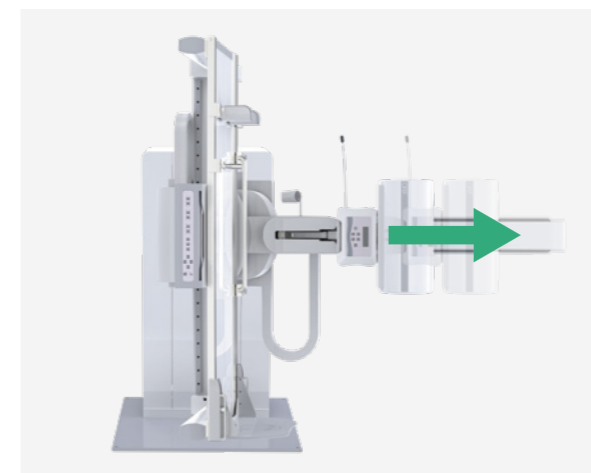

SID stretch

SID 1800mm electric stretching, meet the needs of chest radiography in radiology department.

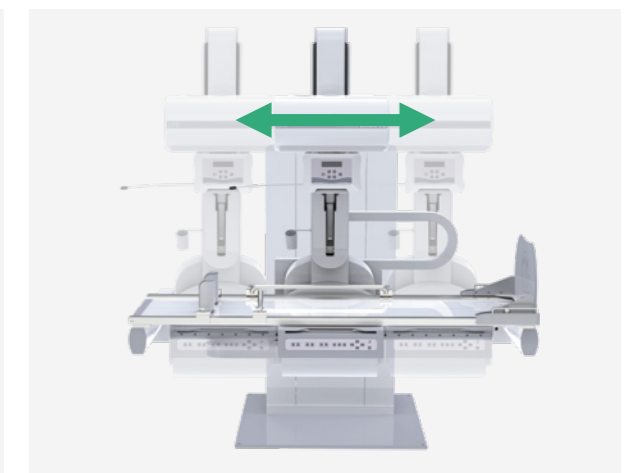

Flexible movement

The detector can be moved in large scale which eliminates the need for Patient re-positioning.

Multiple bed configurations Meet diverse clinical needs

X-ray tube swing system

The tube column can swing at a large angle to meet the needs of clinical tilt angle radiography.



Large angle tube swing



SID stretched to 1.8meters



Large-scale tilting of bed body



Flexible movement

Intelligent bed lifting

Advanced bed lifting function brings great experience for doctors and patients.



Intelligent lifting

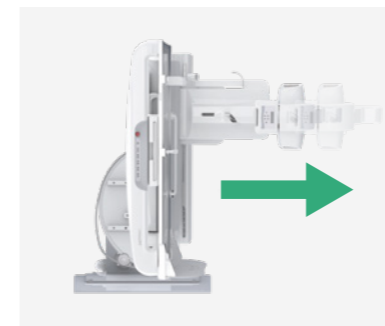

SID stretched to 1.8meters



Large-scale tilting of bed body



Flexible movement

Green, precise and efficient

DAP function (Optional)

- The industry first push DAP radiation dose monitoring system manufacturers, deep technical accumulation.
- DAP intelligent dose monitoring system can record the single examination dose and manage the radiation dose absorption of patients.
- DAP function is an important functional index to measure the quality of X-ray machine, and it is also a necessary function to export to European and American countries.

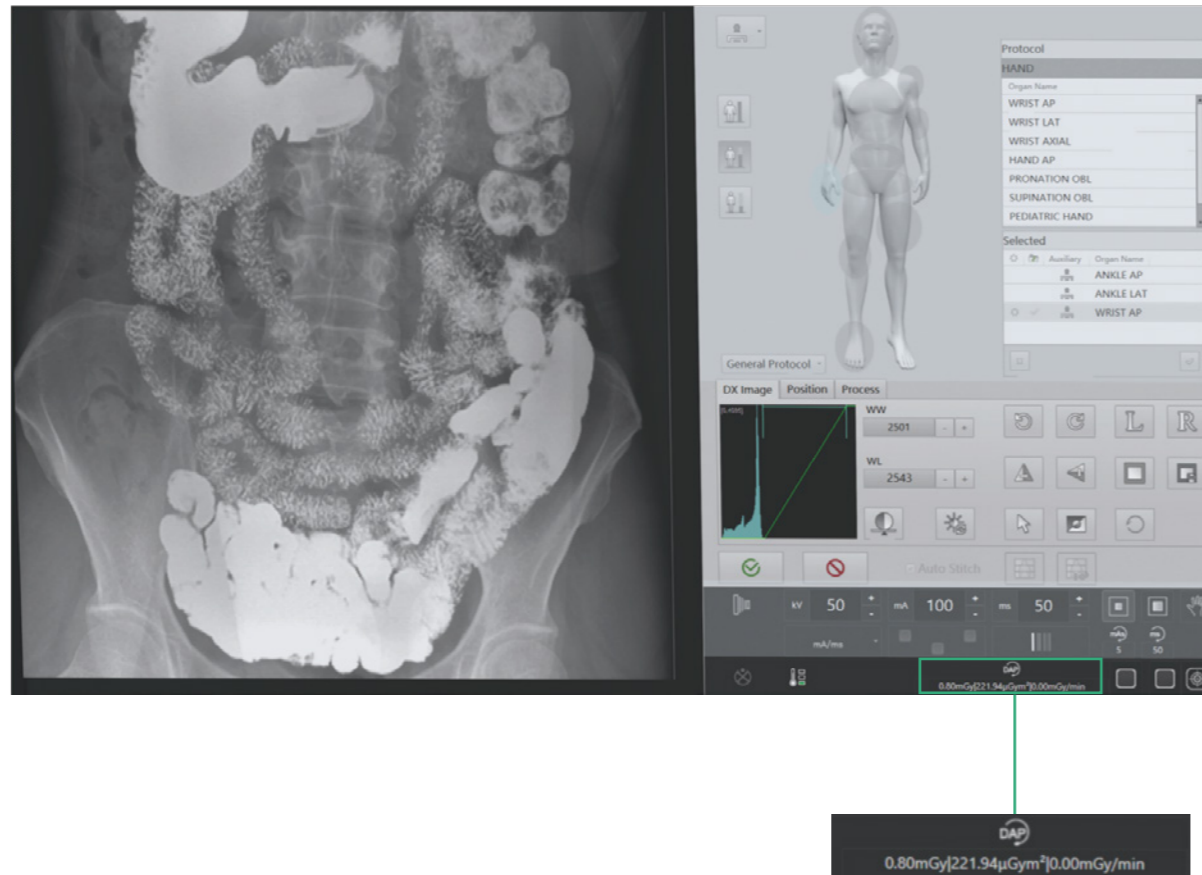

AEC function (Optional)

- Intelligent control exposure time, more efficient.
- Intelligent control of light sensitivity according to different parts.
- Reduces operational difficulties and shortens the workflow.

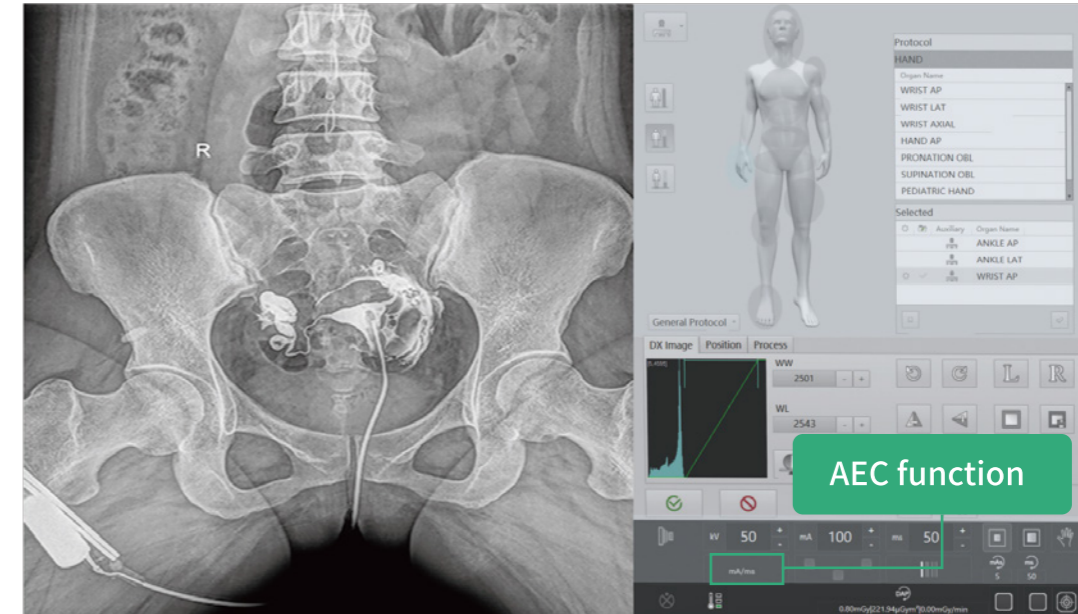

Special surgical proximity console (Optional)

- It can be operated by doctors near the equipment, shorten the distance between the machine room and the operation, observe the patient's condition in real time and carry out reasonable operation, which brings great convenience for carrying out interventional surgery and labor saving, improve the efficiency of doctors.



Intelligent operation Extreme experience

Efficient and convenient software operating system

- Intelligent image acquisition and processing workstation, integrating registration, photography control, image processing and transmission, report printing, film, printing and other functions, with a high degree of integration.
- Humanized menu design makes the operation more convenient. It can switch perspective and shooting modes with one button to optimize the workflow.
- Excellent image post-processing technology. Effectively reduce the dose, improve image quality.

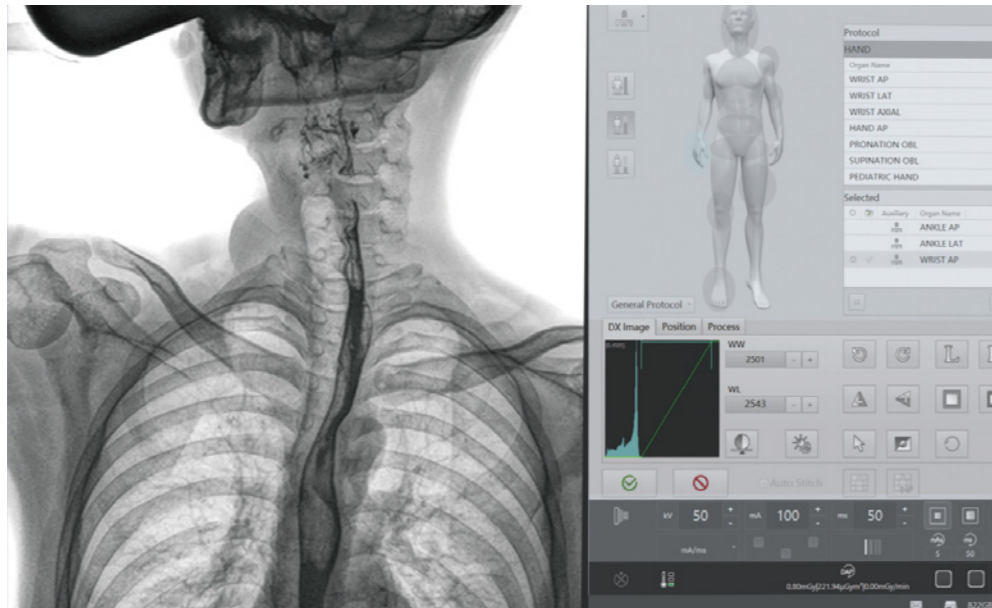



 Image enhancement

 Advanced circle image processing tools

 Window width and level adjustment

 Customized interface flow

 Image cropping function

 Large size monitor

Image stitching (Optional)

- One standard dynamic detector for full stitching functionality.
- Highly practical, low maintenance and cost saving for hospitals.
- Panoramic stitching of full lower limb or full spine images.
- A reliable basis for preoperative planning and postoperative review in the treatment of spinal and lower limb deformities.

