INDEX

1. INTRODUCTION.....	2
Configuration of 961A.....	2
Description of function of 961A panel.....	3
Specifications.....	4
2. INSTALLATION	4
Unpacking.....	4
Safety.....	4
Setting up.....	5
Starting 961A.....	5
Operating 961A.....	5
3. DESCRIPTIONS	6
3.1 General.....	6
3.2 Features	6
3.3 961A consists.....	6
4. Frequent Clinical Urine Flow Curves.....	6
5. PREVENTIVE MAINTENANCE.....	9
5.1 General.....	9
5.2 Checking of the equipment before each use.....	9
6. TROUBLESHOOTING GUIDE.....	10

1. INTRODUCTION

1.1 Configuration of .961A

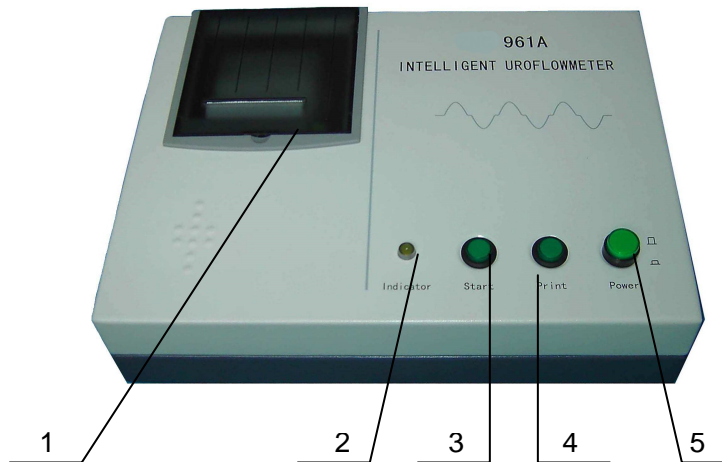

Figure1. 961A's figuration

1. Printer
2. Operation Indicator
3. Startup key
4. Printing key
5. Power switch

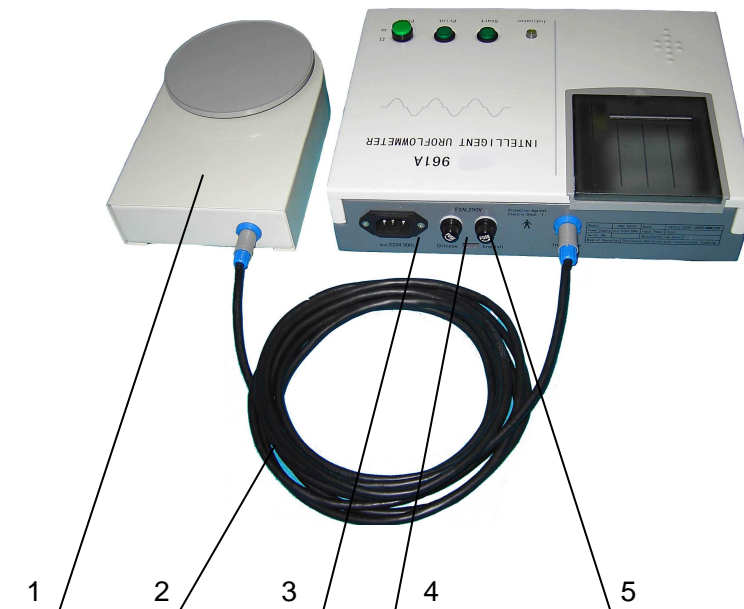

Figure 2 connect sensor-based system with unit

1. Sensor
2. Signal cable
3. Electrical socket
4. Key to selectable language

5. Fuse holder

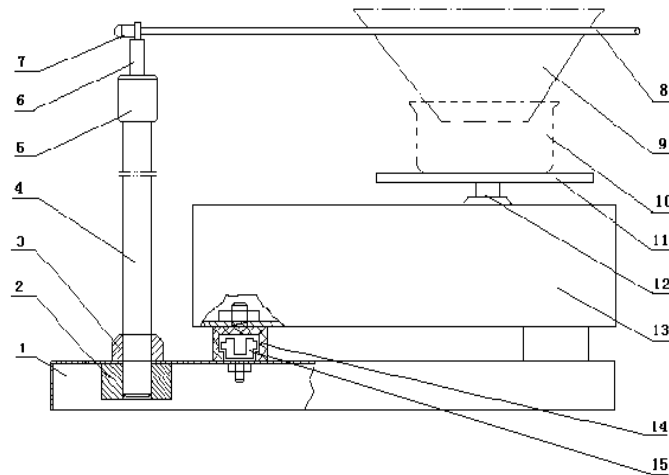

Figure 3 installation of sensor's bracket

1. Base of bracket
2. Screw II
3. Screw I
4. Brace
5. Locknut I
6. Funnel brace
7. Locknut II
8. Funnel stand
9. Paper funnel
10. Collection jug
11. Salver
12. Core
13. Cabinet of sensor
14. Bayonet
15. Chuck

1.2 A full range of clinical measure

- Urine flow curves
- Waiting time
- Voiding time
- Urine flow time
- Time between 10% and 95% of voided volume
- Time to maximum flow
- Maximum flow rate
- Average flow rate
- Voided volume
- 2 seconds flow rate

1.3 Specifications

Power Supply:	220V \pm 10%, 50Hz \pm 1Hz
Measurement range of voided volume:	10ml~1000ml. error \pm 1%
Measurement range of void time:	0s~300s, error \pm 2%
Waiting time to void \leq 300s	
Measurement range of average flow rate:	0ml/s, error \pm 1.5%

2. INSTALLATION

2.1 Unpacking

When unpacking the box, check GDZ 9651 A for any damage and lack. If damaged or missing, please contact our distributor or WBL MEDICAL immediately.

Check-list

- 961A Unit
 - 961A Sensor
- Salver
- Bracket of sensor
- Collection jug
- Power cable
- signal cable
- 20 paper funnels
- 4 thermal printing papers
- two fuses (F2AL250V)
- Instructions Manual
- Warranty card
- Qualified certification
- Packing list (Any change will not be informed, please check according to the list)

2.2 Safety

- a. Before replace the fuse, please pull out the plug.
- b. Operation without a protective earth connection is forbidden.
- c. Before connect the equipment, make sure that the required voltage (showed on the rear panel) is compatible with local main voltage.

NOTE: If the unit still doesn't work after replacing the fuse, return the complete Electrocautery to our distributor or WBL MEDICAL for repair or replacement.

The fuseholder is located on the rear panel, when the fuse needs to be replaced, proceed as follows:

- Disconnect the unit from the main power
- Remove the cover of the fuseholder by hand.
- Fit a new fuse and cover the fuseholder.

e. 961A conforms to the safety requirements IEC 60601-1, ISO13485.

2.3. Setting up

Warning: Connect the mains cable to a mains outlet that has good earth connection.

OPERATION OF THE EQUIPMENT WITHOUT EARTH CONNECTION IS FORBIDDEN.

Notice:

Do not exceed the permissible ambient temperature or humidity.

Avoid the operation environment be filled with EMI

No high frequency interfere power supply system.

Environmental conditions:

Temperature: from 5°C up to 40 °C.

Relative moisture: under 80%

Atmospheric pressure: from 86 kPa up to 106 kPa.

Power supply: 220V±10%, 50Hz± 1Hz

1. Check 961A, and make sure the power and operating indicator are off when the switch is off.
2. Steps of installment bracket of sensor are as follows:
 - ✚ Tighten the screw I before insert the brace into the base of bracket, and then tighten screw II .
 - ✚ Install the funnel brace on the funnel stand and screw the locknut, and embed the module into brace, tighten locknut I , then adjust locknut II to make sure the stand and brace is on the square.
 - ✚ Screw the module of salver and core on the hole of sensor cabinet.
 - ✚ To connect bayonet with chuck, just make the three bayonets (on the bottom of sensor box) aim the corresponding chuck of base and press it upwards.
 - ✚ Set the collection jug on the salver and set paper funnel on the funnel stand.
3. Make paper funnel.
4. Connect signal cable and power cable.
5. Load printer paper.

2.4. Starting 961A

- ✚ After switch it on and press power switch, 961A enter into preparation mode. It will cost 10 seconds for preparation. At the same time, the indicator will illuminate.
- ✚ Press startup key, then the operating indicator lights up.
- ✚ Pour 100ml water into the collection jug and wait for 30 seconds, then the flow curves and flow parameter will be printed automatically to test the operation of instrument is normal or not.

2.5 Operating 961A

- ✚ When the patient want to void, press start key, then the indicator lights up.
- ✚ After patient finish urination 3 seconds, only press printing key, the report is available, or

-
- ✚ After 30 seconds of completing urination, the report is printed automatically. If the interval time of urination exceeds 30 seconds, the remanent urine should be deem as invalid.
 - ✚ If you want to copy report, only press printing key again.
 - ✚ When start a new measurement, please repeat above-mentioned steps.
 - ✚ The measurement was finished, switch off the instrument and clean collection jug.

3. DESCRIPTIONS

3.1 General

961A is a device that measures urine flow rates during micturition, including these parameters: urine flow curves, average flow rate, voided volume, and time of voiding.

3.2 Features:

Simple operation.

Two modes of printing.

A number of flow parameters are precise and reliable.

3.3 961A consists

961A consists of the following components: Unit

Funnel

Collection jug

Bracket of sensor

4. Frequent Clinical Urine Flow Curves

- Maximum flow rate (Q_{max}): male $\geq 15\text{ml/s}$, female $\geq 20\text{ml/s}$, voided volume is 150ml~400ml.
- Q_{max} can be used for screening diagnoses of bladder outflow obstruction (BOO)
- Average flow rate (Q_{ave}): normal flow rate is about half of Q_{max} .
- Flow time (T_Q): is equal to voiding time
- Time to max flow (T_{Qmax}) : normal time is lower 1/3 of voiding time

Clinical flow curves

A. Curves of benign prostatic hyperplasia (BHP)

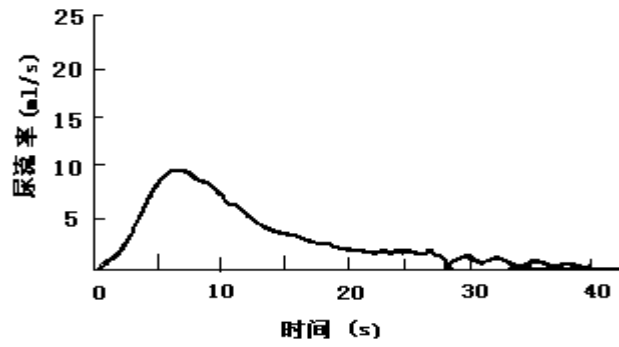

Figure 1 indicates flow time is prolonged in obstruction and has a reduced Q_{max} .

B. Curves of urethral stricture

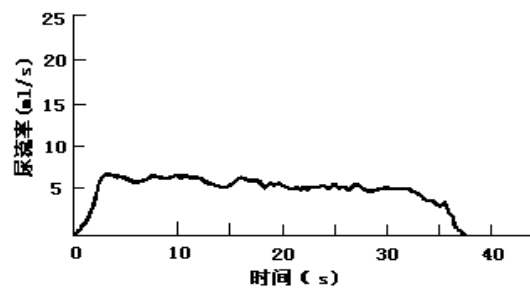

Figure 2 indicates Q_{max} is prolonged as low-level shape

C. Curves of detrusor dysfunction and bladder neck dysfunction

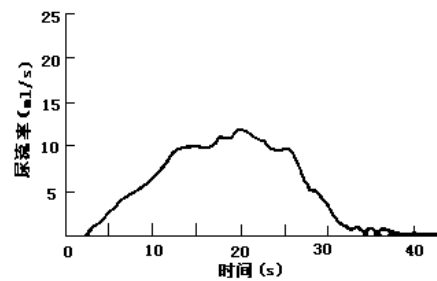

Figure 3 indicates T_{Qmax} is prolonged and has a reduced Q_{max}

D. Curves of external urethral sphincter dysfunction

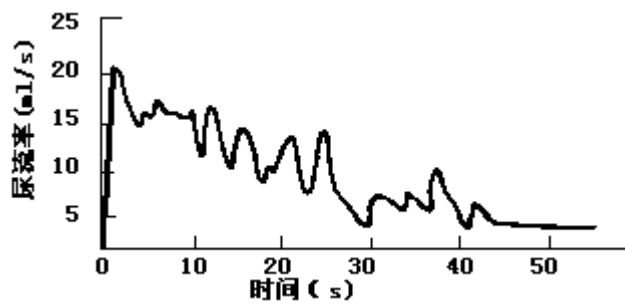

Figure 4 indicates normal curves, but it is manifested as discontinuity.

Attention: Discriminate it from figure 5,6,7

E. Curves is that lumbosacral portion pain causes dysuresia

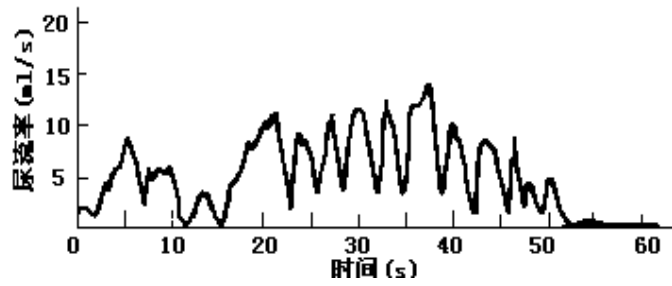

Figure 5 a)

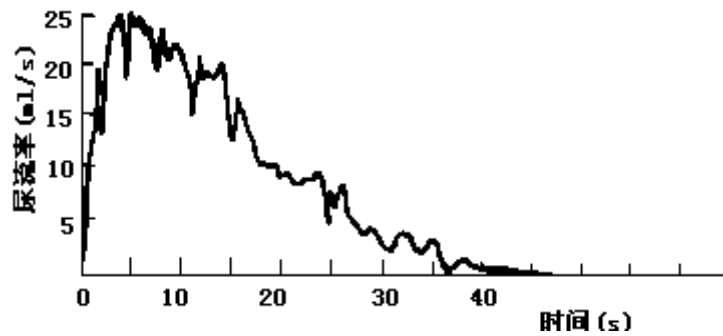

Figure 5 b)

Figure 5 indicates the two-time flow curves measured. The first measurement is in pain, the second is after relieving pain.

F. Curves of benign prostatic pain patient

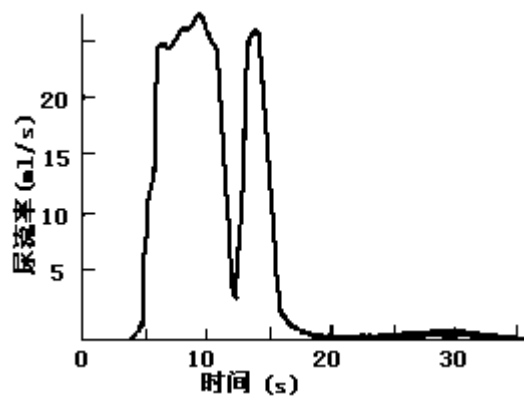

Figure 6 indicates the Q_{max} is fallen. Because of external urthral sphincter cramp, the urine flow appears short intermit.

G. Typical curves of discontinuity micturition.

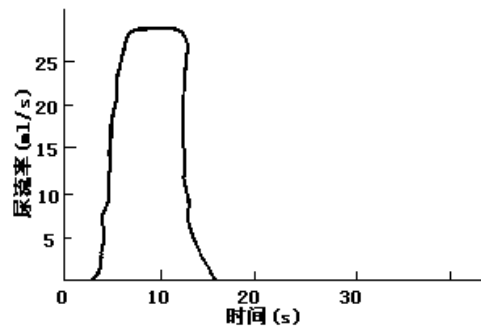

Figure 7 a)

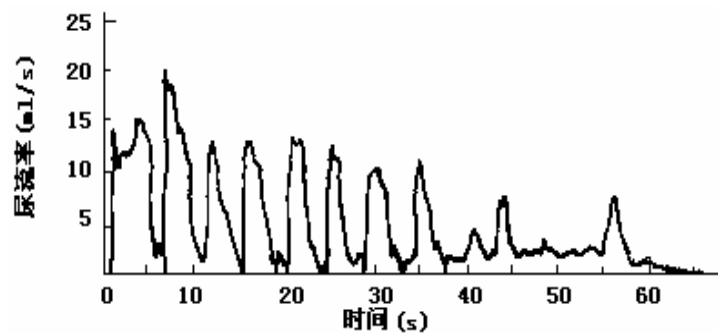

Figure 7 b)

Figure 7 represent nervous lesion of lumbosacral portion cause bladder dysfunction.

5. PREVENTIVE MAINTENANCE

5.1 GENERAL

The equipment must not be opened by the person is not service engineering or other qualified personnel and the warranty is invalidated. In the event any repair or adjustment work is necessary, the whole equipment should be returned to the WBL MEDICAL or our distributors, together with a description of the fault.

Check the equipment and accessory before each use.

After each use, clean the collection jug and wipe the bracket of sensor.

5.2 CHECKING OF THE EQUIPMENT BEFORE EACH USE

Checking of the equipment before use is the most important

- Check the integrity of cables, connections, insulating cover breakage.
- Assure that the equipment is properly grounded.

Assure that all accessories that should be used are available and clean

If the equipment was not used in a long time, Please electrify it once a year to avoid damping.

The instrument should be in dustproof and dampproof when not in use.

6. TROUBLESHOOTING GUIDE

Trouble	Cause	Solution
1. Operating indicator don't illuminate	The fuse was broken, the power plug was not completely inserted into the electrical outlet or the indicator was broken	Replace fuse, indicator or plug it again.
2. The operating indicator doesn't light up after pressing startup key	Control board supply power abnormally or the operating indicator was broken	
3. After finish micturition in 5 minutes, the operating indicator doesn't go out.	Check the operation environment be in EMI or not and make sure that the power supply is stable	
4. Some wrong with printing report		Have a new measurement after shut it down or finish printing.
5. Some wrong with measurement		After shutting instrument down in 10 seconds.